



CORNAY COMPANY, LLC
 1821 Lefthand Circle, Suite B
 Longmont, Colorado 80501
 (303) 651-9099
 Fax: (303) 678-8978
 www.cornay.com

CUSTOM DRIVESHAFT ORDER FORM

Please complete as much of the form as possible and fax to **303-678-8978** or email copy to **info@cornay.com**

Contact

Name _____

Company _____

Title _____

Address _____

City _____ State _____ Zip Code _____

E-mail _____

Phone _____ Fax _____

Application

Application Description _____

Horse Power _____ Speed _____ Torque _____ Angle _____

Billing (optional)

Credit Card Type (Visa, MasterCard) _____

Name on Card _____

Billing Address _____

Card Number _____

Security Code _____ Exp Date _____

APPLICATION INFORMATION

FILL IN AS MUCH DETAIL AS POSSIBLE

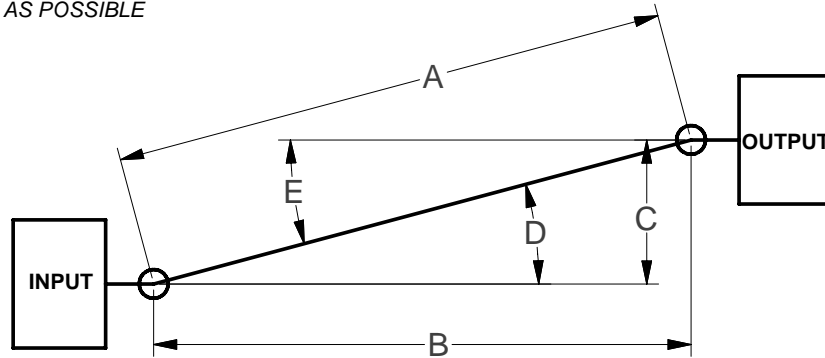
MEASUREMENTS
A - Joint center to joint center _____

B _____

or - Flange center to joint center _____

C _____

or - Flange center to Flange center _____

D _____

E _____

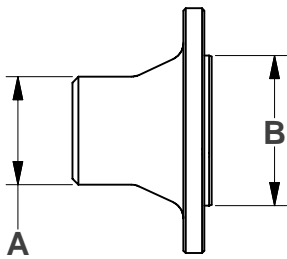
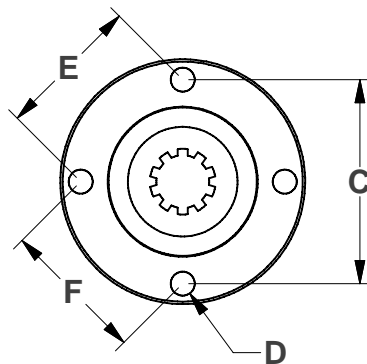
ATTACHMENTS

FLANGE

OUTPUT ATTACHMENT

(FLANGE OR HALF ROUND) _____

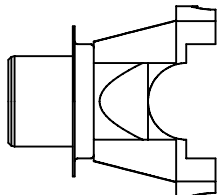
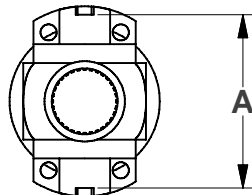
(SPLINED OR KEYED) _____

A _____ **B** _____ **C** _____

D _____ **E** _____ **F** _____

HALF ROUND

INPUT ATTACHMENT

(FLANGE OR HALF ROUND) _____

(SPLINED OR KEYED) _____

A _____ **B** _____ **C** _____

D _____ **E** _____ **F** _____

 DESCRIBE APPLICATION

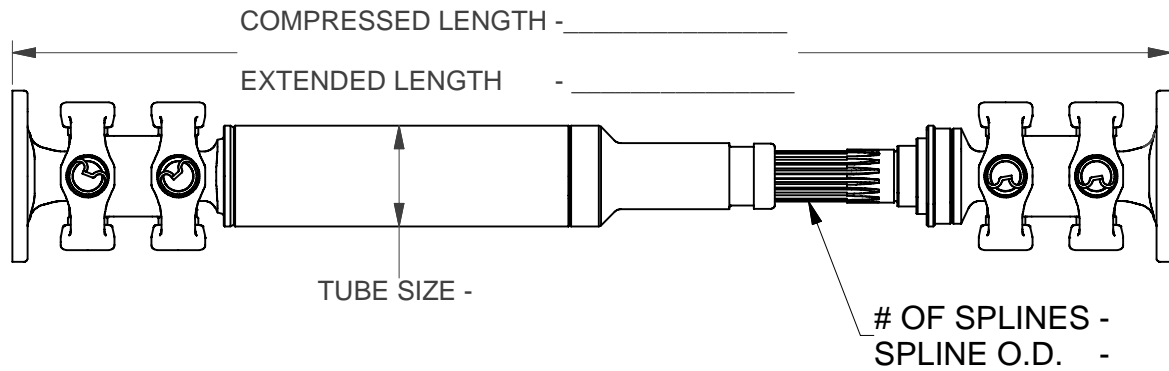
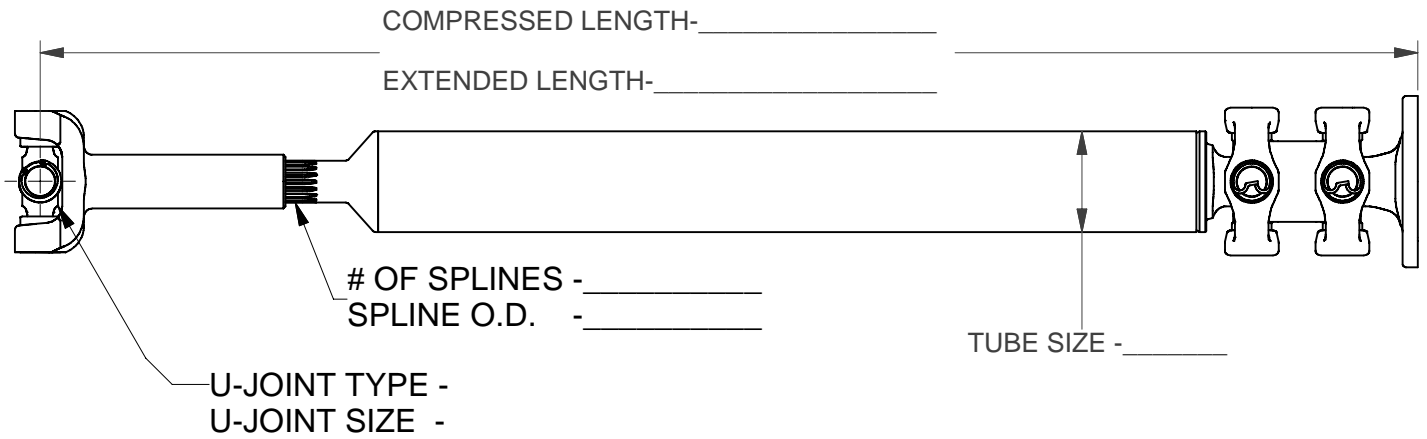
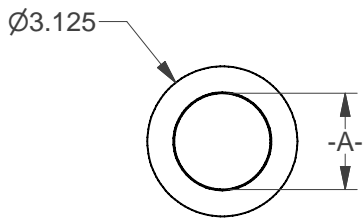
CORNAY CVX30 COMBINATION FLANGE CONFIGURATION

Currently available Cornay flanges have a female pilot of 3.125in. diameter. Please specify required pilot bushing I.D.

PILOT BUSHING DIAMETER -A- _____

